

NOAH 2000

Balcony Solar Storage User Manual

Contact us

www.ginverter.com

1. Keep it dry and do not place heavy objects on the NOAH 2000.
2. Do not dismantle, punch, shake, hit, or burn it.
3. Recycle and place NAOH 2000 according to local policies.

Content

DISCLAIMER	3
PACKING LIST	3
SPECIFICATION	3
SAFETY GUIDELINES	4
OVERALL INTRODUCTION	5
PRODUCT APPEARANCE	5
LED Panel and Buttons	6
INSTALLATION	6
Application 1: NOAH 2000 (×1) +Solar Module (×2)	6
Application 2: NOAH 2000 (×1) +Solar Module (×4)	7
Application 3: NOAH 2000 (×2) +Solar Module (×4)	8
MOUNTING METHOD	9
Floor Installation	9
Wall-Hung Installation	10
HOW TO START	10
Power On/Off	10
App	10
Cold-start	15
FAQ	15
MALFUNCTION	16
Alert & Failure	16
Main Troubleshooting	18

DISCLAIMER

Please read the document carefully before you use the product to ensure that you completely understand the product and can correctly use it. After reading, please keep the document properly for future reference. If you use this product incorrectly, you risk significant injury to yourself or others, as well as product damage and property loss. Once you use this product, you are deemed to have understood, approved, and accepted all the terms and content of this document. Users promise to be responsible for their actions and all consequences arising therefrom. Growatt is not responsible for any damage caused by using the product not in accordance with the document.

PACKING LIST

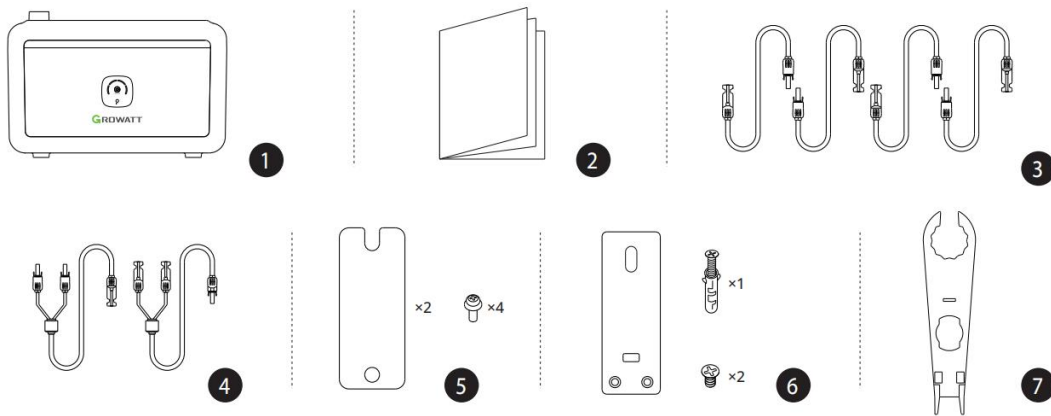

- 1.NOAH 2000 Balcony Solar Storage
- 2.Documentations (Disclaimer & Warranty & Quick Start Guide & APP Guide)
- 3.PV Input Extension Cable
- 4.DC Output Cable
- 5.Cable Locker
- 6.Fix-Bracket
- 7.H4 Withdrawal Tool

SPECIFICATION

Basic Information	
Net Weight	≈23kg
Dimensions(L*W*H)	406×235×270mm
Wi-Fi	Supported
Bluetooth	Supported
LED Display	Supported
Ingress Protection	IP66
Input	

PV Input 1	16-60V \Rightarrow , 26A, 900W MAX
PV Input 2	16-60V \Rightarrow , 26A, 900W MAX
Total Input	1800W MAX
Output	
DC Output	40-50V \Rightarrow , 18A, 800W MAX
Battery	
Capacity	51.2V*40Ah (2048Wh)
Battery Type	LFP(Lithium Iron Phosphate)
Protection Types	High-Temperature Protection, Low-Temperature Protection, Over-Discharge Protection, Over-Charge Protection, Overload Protection, Short Circuit Protection, Over-Current Protection
Operating Environment Temperature	
Charge Temperature	0~45°C / 32~113°F
Discharge Temperature	-20~45°C / -4~113°F

SAFETY GUIDELINES

Product Usage

1. Do not place this product in high temperature environments or in fire.
2. Avoid exposing it to moisture or submerging it in liquids.
3. Do not use near strong electrostatic or magnetic fields. Such conditions may disable some protective features of the product, leading to severe malfunctions.
4. Do not disassemble this product. Consult official channels for service or repair. Improper disassembly or reassembly may pose a risk of fire or personal injury.
5. When using this product, adhere strictly to the operational temperature range specified in the user manual. Excessive temperatures may cause fire or explosion; low temperatures can significantly reduce performance or cause the product to fail and cease functioning.
6. Do not place the product in unventilated areas during use.
7. Avoid causing a short circuit in the product with wires or other metal objects.
8. Ensure the product is not subjected to impact, drops, or severe vibration. Secure it during transport to prevent damage. If severely damaged, immediately turn off the power and cease using the product.
9. If the product accidentally falls into water, place it in a safe, open area and stay away from it until it is completely dry. Do not reuse a dried product; dispose of it properly as per the instructions in this document.
10. Growatt is not responsible for accidents or malfunctions caused by parts not provided by Growatt.
11. Clean the product only with a dry cloth.
12. Place it on a flat surface to prevent it from falling. If it topples over and is severely damaged, immediately turn it off; place the battery in an open area, away from people and flammable materials, and dispose of it in accordance with local laws and regulations.
13. Keep out of reach of children and pets.
14. Electromagnetic fields inevitably generated during the use of power products may affect the normal functioning of implanted medical devices or personal medical devices, such as pacemakers, implanted cochlear implants, hearing aids, defibrillators, etc. If you use such medical devices, consult their manufacturers for restrictions on using related equipment to ensure a safe distance is maintained between the product and implanted medical devices (like pacemakers, cochlear implants, hearing aids, defibrillators, etc.) during operation.

II. Storage and Maintenance

1. Store the NOAH 2000 out of children's reach. If a child accidentally swallows any parts, seek medical assistance immediately.
2. After using, if the machine indicates low battery, charge it before storage. Extended storage with low battery may damage the internal battery. If the battery is severely depleted and left idle for too long, it will enter a deep sleep mode. To awaken the battery from deep sleep, charge the machine.
3. Do not place the machine near heat sources, such as in direct sunlight inside a car, near fire, or beside a heater.
4. The storage environment for the machine should be dry. Do not place the machine in water or in potentially wet areas. To extend battery life for long-term storage, keep the battery level between 30% and 80%, and turn off the main switch for indoor storage. It is recommended to charge it to 80% every three months.
5. Do not air transport the machine if its battery level is above 30%.

III. Disposal Guide

1. Be sure to completely discharge the machine battery before placing the machine battery in the proper disposal location as per local rules and regulations. Batteries are hazardous chemicals and should not be disposed of in ordinary trash cans. Follow local laws and regulations for battery recycling and disposal.
2. If the product itself fails and the battery cannot be fully discharged, please do not dispose of the battery directly in the battery recycling box. Contact a professional battery recycling company for further processing.
3. Please dispose of overcharged batteries.

OVERALL INTRODUCTION

PRODUCT APPEARANCE

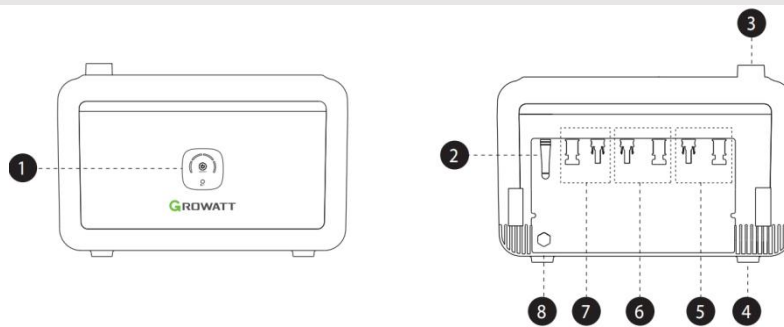

1. LED Panel
2. Signal Antenna
3. Battery Expansion Port (Female)
4. Battery Expansion Port (Male)

5. PV Input Port 1
6. PV Input Port 2
7. DC Output Port
8. Vent Valve

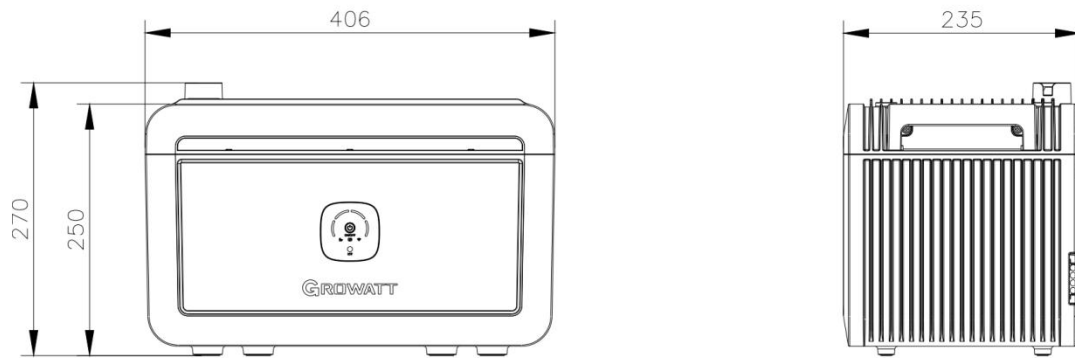

Model	Length	Width	Height	Weight
NOAH 2000	406mm	235mm	270mm	≈23kg

LED PANEL AND BUTTONS

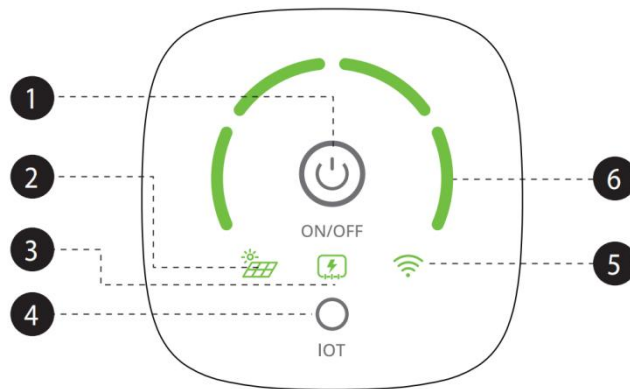

1. Main Power Button: Short press for 1 second to turn on; long press for 3 seconds to turn off.
2. Solar Panel Connection Indicator: The icon lights up to indicate solar panel connection. When the PV input power is below 25W, the icon flashes quickly; when it exceeds this value, the icon remains steadily lit.
3. Micro-inverter Operation Indicator: The icon lights up to indicate that the NOAH 2000 is powering the micro-inverter.
4. IoT Button (WiFi-Bluetooth):
 - a. Short press for 1 second, IOT icon blinks, indicating it's ready to connect.
 - b. IOT icon stays on, indicating a successful connection.
 - c. Long press for 3 seconds to reset, IOT icon blinks.
5. IoT Indicator (WiFi-Bluetooth): The icon lights up to indicate successful network pairing.
6. Battery Level Indicator: Shows the percentage of battery charge, with one bar representing 0-25%. When the battery level is 0-10% and the entire system is in standby or discharging mode, the first indicator light on the left flashes quickly.

INSTALLATION

1. When wiring, please ensure that the wire labels correspond to the markings on the enclosure.
2. When stacking three or more units, wall fixation is required to prevent tipping. A maximum of four units can be stacked.
3. Avoid direct sunlight on the product.

APPLICATION 1: NOAH 2000 (×1) +SOLAR MODULE (×2)

1. Connect DC Output Cable to NOAH 2000.

2. Attach PV Input Extension Cable to NOAH 2000.
3. Secure all cables with Cable Locker (Torque 1.5N·m).
4. Connect micro-inverter to NOAH 2000, then plug into household socket.
5. Connect solar panels to NOAH 2000.

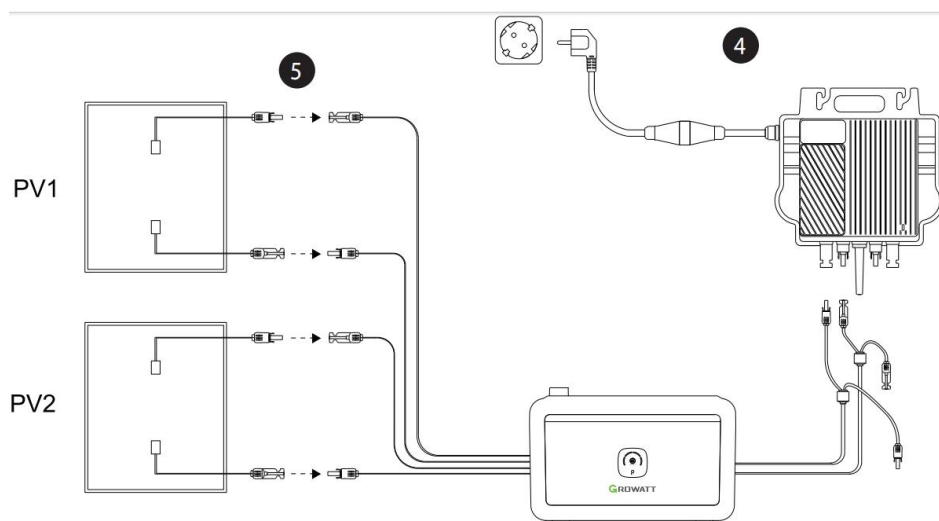
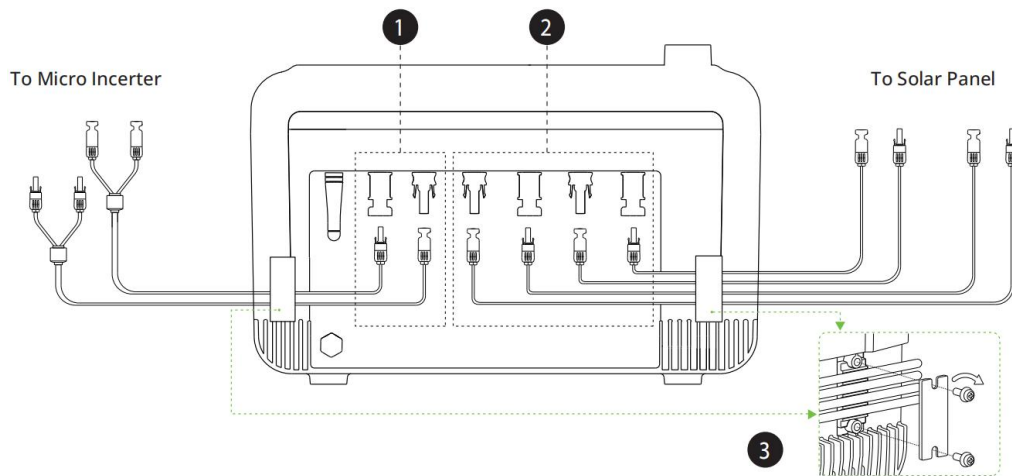

APPLICATION 2: NOAH 2000 (×1) + SOLAR MODULE (×4)

1. Connect DC Output Cable to NOAH 2000.
2. Attach PV Input Extension Cable to NOAH 2000.
3. Secure all cables with Cable Locker (Torque 1.5N·m).
4. Connect micro-inverter to NOAH 2000, then plug into household socket.
5. Wiring solar panels with Y-Branch Solar Parallel Cable (sold separately), then connect to the NOAH 2000.

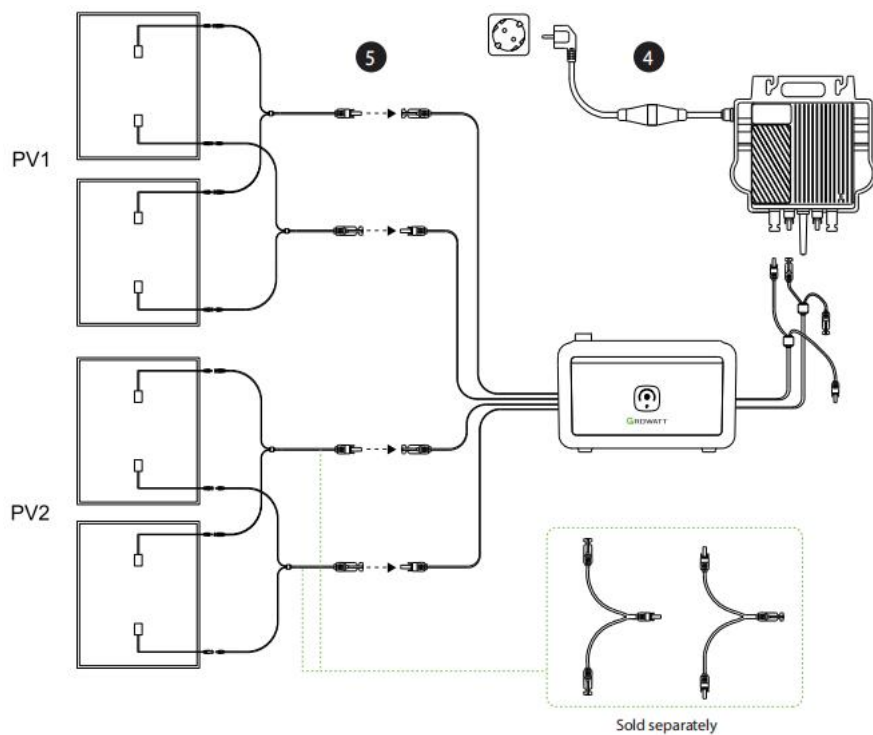
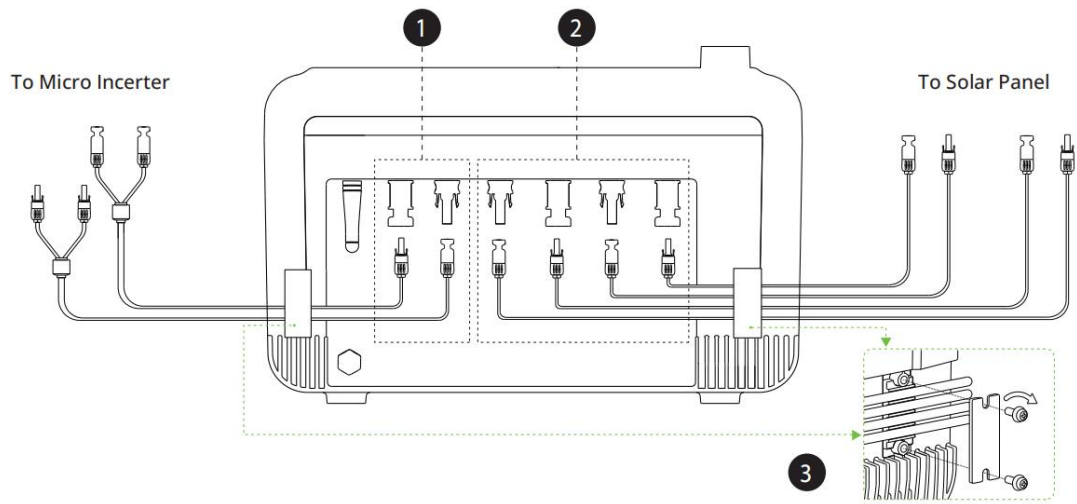

APPLICATION 3: NOAH 2000 (×2) + SOLAR MODULE (×4)

1. Connect DC Output Cable to NOAH 2000.
2. Attach PV Input Extension Cable to NOAH 2000.
3. Secure all cables with Cable Locker (Torque 1.5N·m).
4. Stack 2 units together.
5. Connect micro-inverter to NOAH 2000, then plug into household socket.
6. Connect solar panels to NOAH 2000.

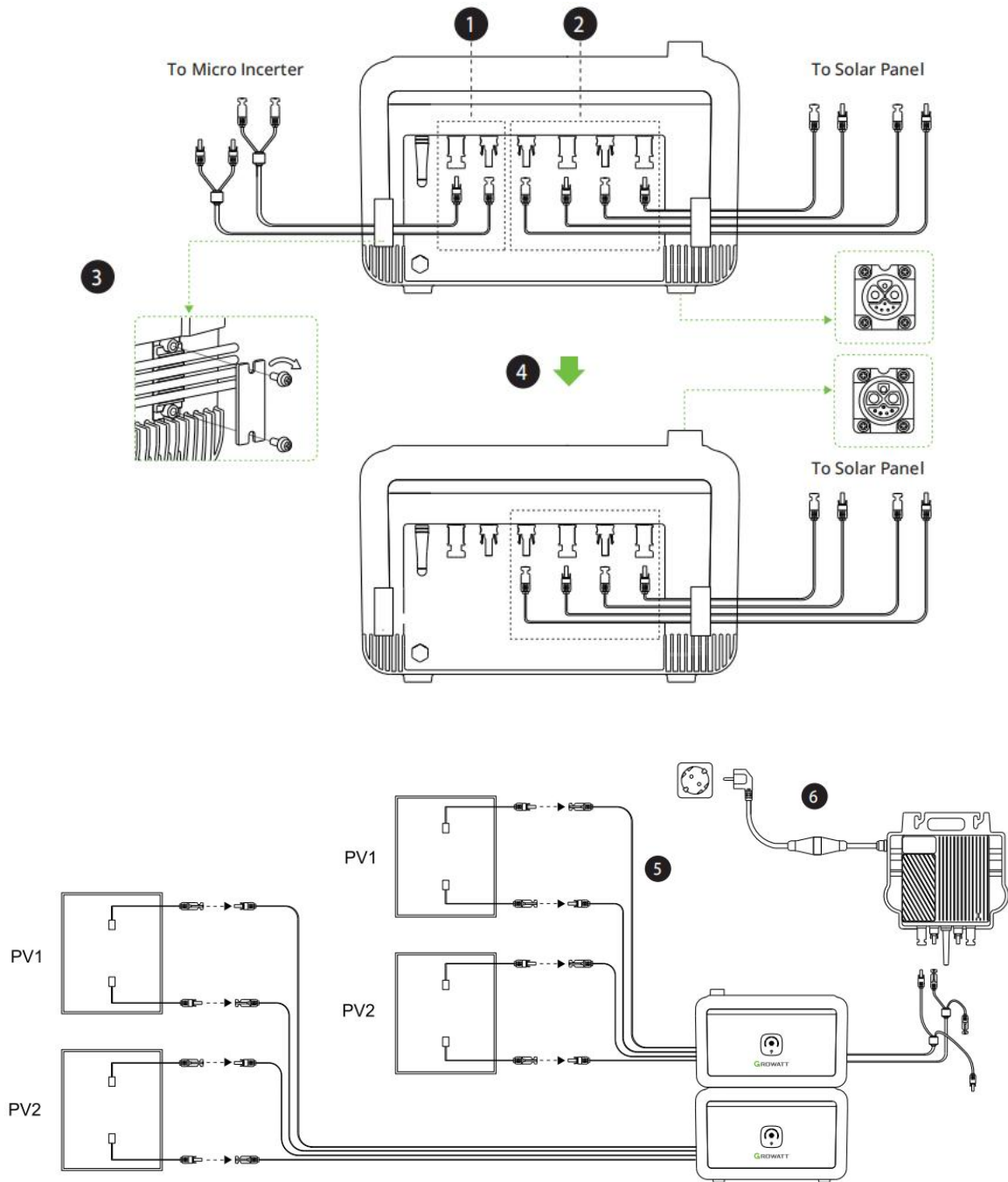

MOUNTING METHOD

FLOOR INSTALLATION

NOAH 2000 supports stacked installation, with a recommended maximum of 4 units.

Fix-bracket can be used to enhance stability as follows:

1. Install Fix-Bracket onto NOAH 2000 (Torque 1.5N·m).
2. Mark the wall after positioning NOAH 2000.
3. Drill holes(Φ6*30mm) at the marked spots , and insert expansion plugs.
4. Secure NOAH 2000 to the wall (Torque 1.2N·m).
5. The stacking should appear as shown in the illustration.

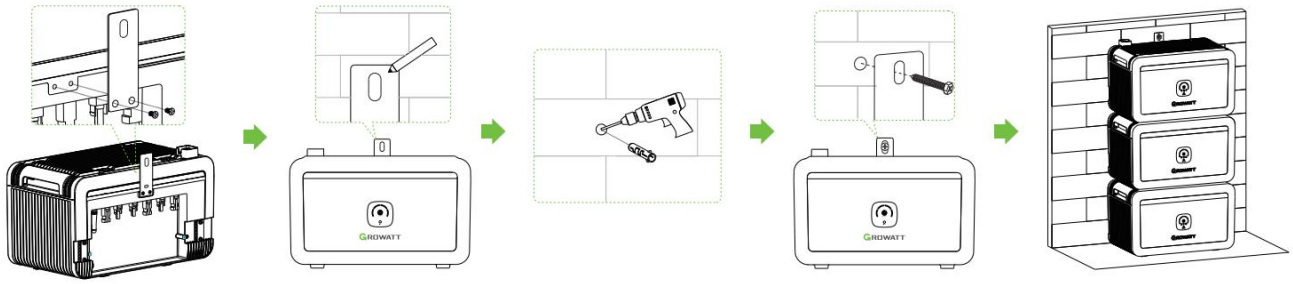

WALL-HUNG INSTALLATION

NOAH 2000 supports Wall-Hung to minimize the use of balcony floor space.

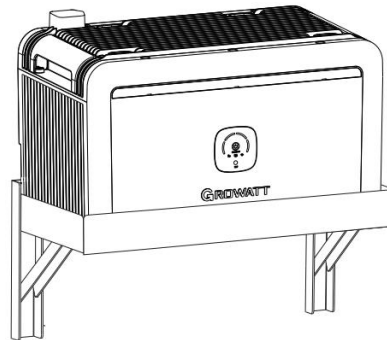

*This Wall-Hung bracket is sold separately.

HOW TO START

POWER ON/OFF

Short press the main power button for 1 second to turn on; long press the main power button for 3 seconds to turn off.

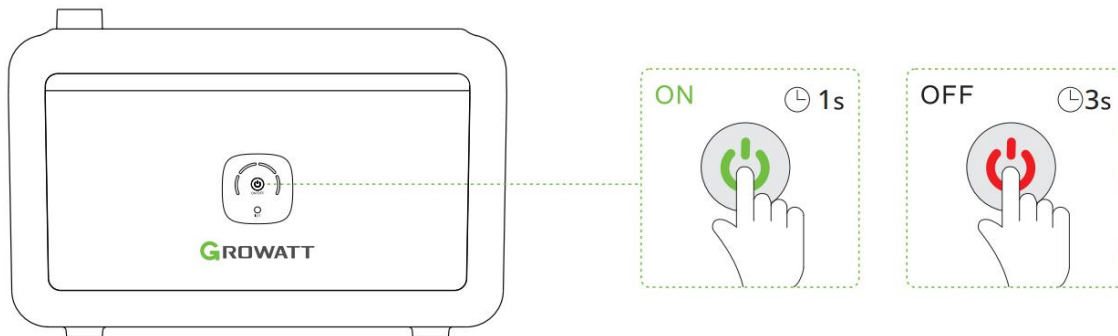

APP

Note: The figures are for reference only. Please refer to the actual APP interface.

Use the ShinePhone application to remotely monitor and control your Noah 2000 Balcony Solar Storage system.

Create A Power Plant

1. Scan the QR code to download the 'ShinePhone' APP. You can also search for 'ShinePhone' on the APP Store or Google Play to download.



2. Click "Register" to create an account.

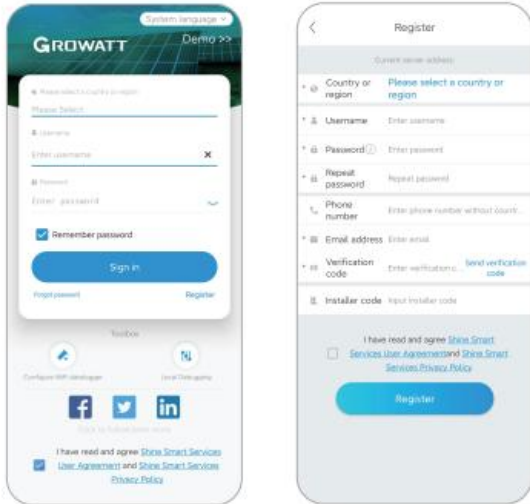

3. Create a power plant: Set the time and location according to the actual situation, and fill in the PV capacity and grid electricity price information.

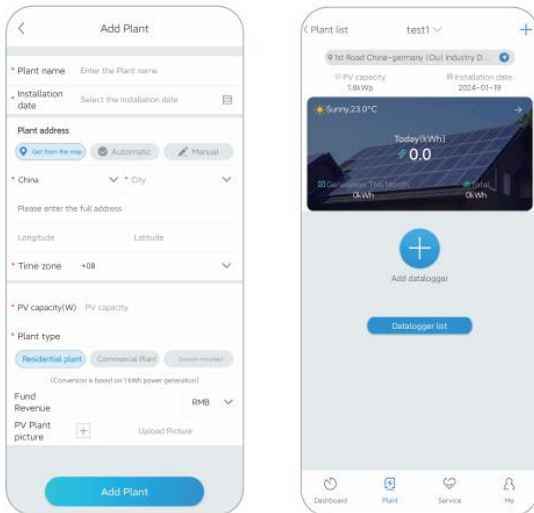

Configure Network

4. Connect Noah 2000 to the network

4.1 Find and enter the "Plant" page from the bottom menu. Click the "+" button in the upper right corner of the page, select "Add device", scroll down and choose "NOAH 2000 Balcony Solar Storage".

4.2 Follow the instructions on the app to complete the remaining distribution steps and add it to the power plant.



Note:

- 1). When stacking multiple devices, only the topmost device needs to be turned on, and the other devices will automatically turn on.
- 2). When stacking multiple devices, simply light up the IoT icon of the topmost device and do not light up the IoT icons of the other devices.
- 3). Re-pair the product with a new mobile device: If the device is already bound to a mobile device, you need to press the device's IoT button for 3 seconds to unpair the product from the current device and then re-pair it with the new mobile device.

Page Introduction

5. Page of your Noah 2000 Balcony Solar Storage System

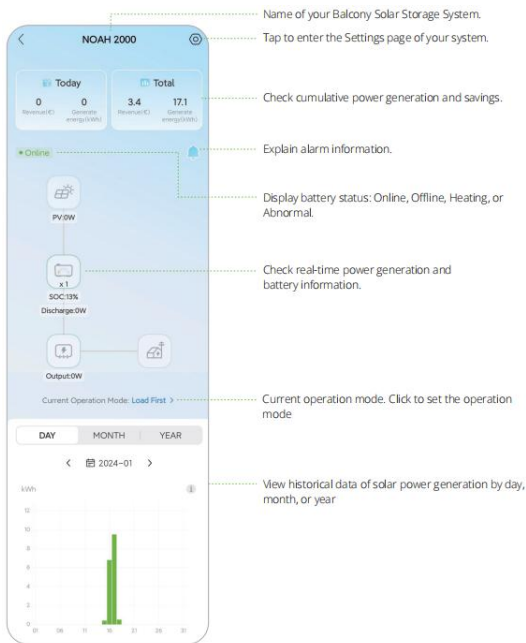

Set Operation Mode

6. Set Operation Mode

6.1 Click "Add time", add a time period, and select a work mode for that time period.

Load First Mode: It is a setting that prioritizes the use of photovoltaic power to power the load. If the photovoltaic energy generated is more than the System Output Power you have set, the excess energy will be stored in the battery. Conversely, if the photovoltaic energy generated is less than the System Output Power you have set, the battery will be discharged automatically to power the load along with the photovoltaic energy.

Battery First Mode: It is a setting that prioritizes the use of photovoltaic power to charge the battery until it reaches its upper limit SOC, at which point the battery stops discharging. When the battery is fully charged and there is still photovoltaic energy, it will output according to the actual photovoltaic power.

Note: The default is Load First Mode, and the default system output power is set to 200W. You can adjust this value to your preferred level within the APP.

6.2 Click on the "?" icon in the upper right corner to view detailed operating instructions.

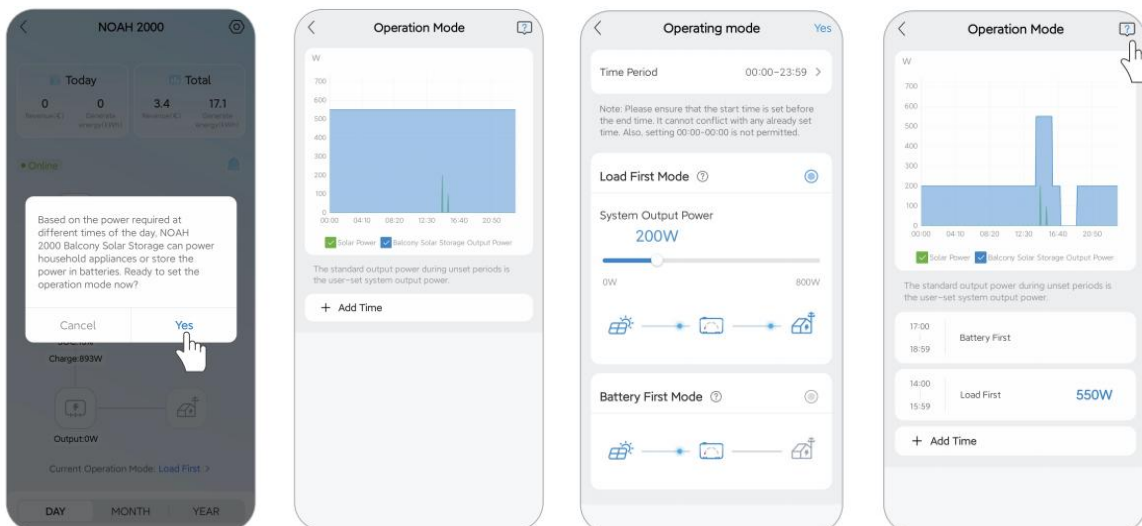

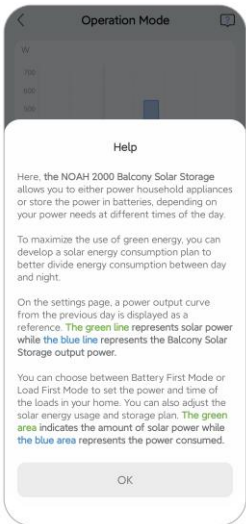

Other Important Settings

7. Associated Inverter

7.1 Click the settings button in the upper right corner to enter the settings page.

7.2 Click on "Associated Inverter" to associate it with your inverter.

Note: This setting only applies to scenarios used in conjunction with Growatt NEO Micro Inverter.

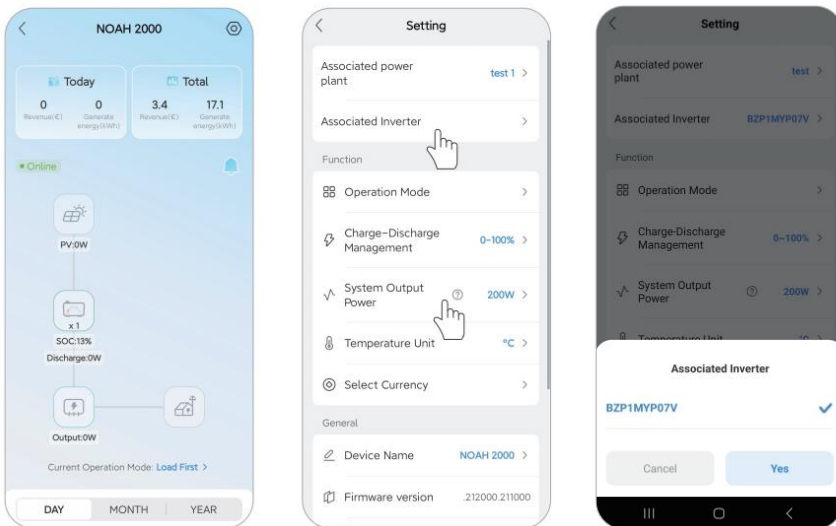

8. Set System Output Power

8.1 Click "System Output Power" and set the output power you need.

8.2 This is the default output power. During periods when no Operation Mode settings are applied, the system outputs at the default power level.

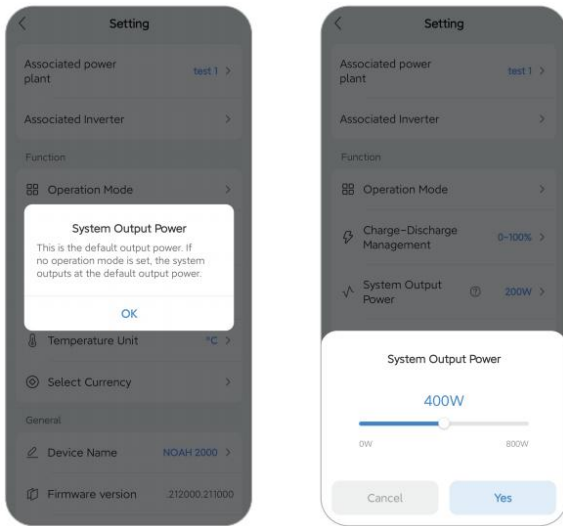

COLD-START

When the battery temperature is between -30°C and -20°C , connecting solar panels with photovoltaic input can automatically heat the battery to the working temperature, allowing the NOAH 2000 to function normally, thus enabling its use in low-temperature environments.

Battery temperature	Remaining heating time/min
-30°C	83
-25°C	75
-20°C (Minimum allowable discharge temperature)	65
-15°C	54
-10°C	42
-5°C	29
0°C (Minimum allowable charging temperature)	15
5°C	0

*Note:

1. This estimated remaining heating time is calculated based on the maximum heating power (photovoltaic input power $\geq 140\text{W}$) and is for reference only. Actual results may vary. The heating function will stop when the battery temperature reaches 5°C .
2. Remaining heating time: The time required to heat from the current temperature to 5°C . For example, if the current temperature is -20°C , it takes 65 minutes to heat up to 5°C .
3. If the NOAH 2000 is below 0°C and the photovoltaic input power is $\leq 140\text{W}$, the photovoltaic energy is prioritized for battery heating.

FAQ

Q1: Does NOAH 2000 support simultaneous charging and discharging?

Yes, the input/output ports of NOAH 2000 are different, allowing simultaneous charging and discharging.

Q2: Is it possible to charge NOAH 2000 with solar panels from other brands?

Yes, just meet the photovoltaic charging specifications of this product.

Q3: How to store my NOAH 2000?

If long-term storage is required, please fully charge the machine, disconnect the photovoltaic connection, and then turn off the machine. Charge and discharge the product every 3 months: first discharge it to 20%, then charge it to 80%.

Q4: Can one battery be connected to four solar panels?

Sure, you can purchase the Y-Branch Solar Parallel Cable to connect 4 solar panels.

Q5: What is the waterproof performance of this device?

NOAH 2000 has an IP66 rating, making it suitable for outdoor use in challenging conditions, whether it's dusty environments or unexpected rain showers.

Q6: How to monitor the electricity generation of NOAH 2000 Solar Balcony Storage system?

On the ShinePhone app, you can monitor solar power generation data and regulate the system's real-time output power.

Q7: How does NOAH 2000 Solar Balcony Storage operate?

NOAH 2000 supports two working modes: Load First Mode and Battery First Mode. Users can set different working modes at different time periods as needed.

The system operates on a Load First mode by default, which prioritizes the use of photovoltaic power to power the load. If the photovoltaic energy generated is more than the system output power, the excess energy will be stored in the battery. Conversely, if the photovoltaic energy generated is less than the system output power, the battery will be discharged automatically to power the load along with the photovoltaic energy. The default system output power is set to 200W, but users can adjust this value to their preferred level within the app.

Battery First mode is a setting that prioritizes the use of photovoltaic power to charge the battery until it reaches its upper limit SOC, at which point the battery stops discharging. When the battery is fully charged and there is still photovoltaic energy, it will output according to the actual photovoltaic power.

MALFUNCTION

ALERT & FAILURE

APP Displayed Fault Code	APP Displayed Fault Content	Solution
A01	Low Battery Voltage Alarm	Please charge promptly. If the problem persists after 2-3 hours of charging, contact Growatt Customer Service Center for repair.
A02	High Battery Voltage Alarm	Turn off photovoltaic input and restart the product. If the issue continues after multiple attempts, contact Growatt Customer Service Center for repair.
A03	Low Battery Charging Temperature Alarm	Use in a warmer location or connect to photovoltaic input and wait before using.
A04	High Battery Charging Temperature Alarm	Shut down the product. After cooling for 2-3 hours, it can be reopened and should work normally.
A05	Low Battery Discharge Temperature Alarm	Use in a warmer location or connect to photovoltaic input and wait before using.
A06	High Battery Discharge Temperature Alarm	Shut down the product. After cooling for 2-3 hours, it can be reopened and should work normally.
A07	Battery Overcharge Current Alarm	Restart the product. If the problem persists after multiple attempts, contact Growatt Customer Service Center for repair.

A08	Battery Overdischarge Current Alarm	Restart the product. If the problem persists after multiple attempts, contact Growatt Customer Service Center for repair.
A09	Communication Failure with BMS	Restart the product. If the problem persists after multiple attempts, contact Growatt Customer Service Center for repair.
A10	Communication Failure with MPPT	Restart the product. If the problem persists after multiple attempts, contact Growatt Customer Service Center for repair.
F01	PV1 Overvoltage Protection	Check if input conforms to photovoltaic charging specifications. Disconnect photovoltaic input or restart the product to resume normal operation.
F02	PV1 Overcurrent Protection	Check if input conforms to photovoltaic charging specifications. Disconnect photovoltaic input or restart the product to resume normal operation.
F03	PV1 Overtemperature Protection	Shut down the product. After cooling for 2-3 hours, it can be reopened and should work normally.
F04	PV2 Overvoltage Protection	Check if input conforms to photovoltaic charging specifications. Turn off photovoltaic input to resume normal operation.
F05	PV2 Overcurrent Protection	Check if input conforms to photovoltaic charging specifications. Disconnect photovoltaic input or restart the product to resume normal operation.
F06	PV2 Overtemperature Protection	Shut down the product. After cooling for 2-3 hours, it can be reopened and should work normally.
F07	DC Output Low Voltage Protection	Restart the product. If the issue persists after multiple attempts, contact Growatt Customer Service Center for repair.
F08	DC Output High Voltage Protection	Restart the product. If the issue persists after multiple attempts, contact Growatt Customer Service Center for repair.
F09	Whole Unit Overtemperature	Shut down the product. After cooling for 2-3 hours, it can be reopened and should work normally.
F10	DC Output Overload Protection	Reduce the load to resume normal operation. Prolonged overload may damage the product.
F11	Low Battery Voltage Protection	Please charge in time. If the problem persists after 2-3 hours of charging, contact Growatt Customer Service Center for repair.
F12	High Battery Voltage Protection	Turn off photovoltaic input, restart the product. If the issue persists after multiple attempts, contact Growatt Customer Service Center for repair.
F13	Low Battery Charging Temperature Protection	Use in a warmer location or wait after connecting to photovoltaic input before using.
F14	High Battery Charging Temperature Protection	Shut down the product. After cooling for 2-3 hours, reopen and use normally.
F15	Low Battery Discharge Temperature Protection	Use in a warmer location or wait after connecting to photovoltaic input before using.
F16	High Battery Discharge Temperature Protection	Shut down the product. After cooling for 2-3 hours, reopen and use normally.
F17	Battery Overcharge Current Protection	Restart the product. If the issue persists after multiple attempts, contact Growatt Customer Service Center for repair.
F18	Battery Overdischarge Current Protection	Restart the product. If the issue persists after multiple attempts, contact Growatt Customer Service Center for repair.
F19	Battery Error	Restart the product. If the issue persists after multiple attempts, contact Growatt Customer Service Center for repair.
F20	Battery Temperature Sampling Anomaly	Restart the product. If the issue persists after multiple attempts, contact Growatt Customer Service Center for repair.
F21	Battery Voltage Sampling Anomaly	Restart the product. If the issue persists after multiple attempts, contact Growatt Customer Service Center for repair.

MAIN TROUBLESHOOTING

Fault Phenomenon	Troubleshooting	Solution Strategy
No PV Input in NOAH 2000	Check if the PV input extension cord is properly connected.	Recheck if the PV input interface is in good contact.
	Check if the PV input extension cord is intact.	If damaged, replace it promptly.
	Check if the PV connection indicator on the LED screen is lit.	Recheck if the PV connection indicator on the LED screen is lit.
	All above are fine, but still no PV input in NOAH 2000.	Contact Growatt Customer Service Center for repair.
NOAH 2000 Cannot Output Normally	Check if the DC output cable is properly connected.	Recheck if the DC output interface is in good contact.
	Check if the DC output cable is intact.	If damaged, replace it promptly.
	Check if the micro-inverter connection indicator on the LED screen is lit.	Recheck if the micro-inverter connection indicator on the LED screen is lit.
	All above are fine, but NOAH 2000 still cannot output normally.	Contact Growatt Customer Service Center for repair.